

FUJI RING BLOWERS

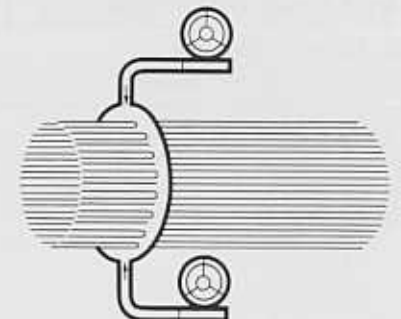
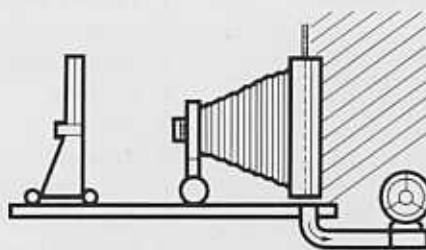
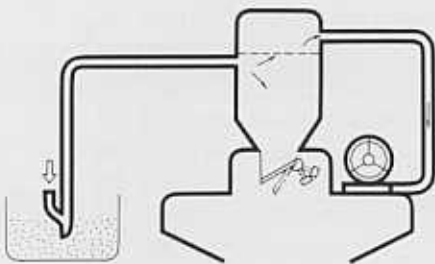
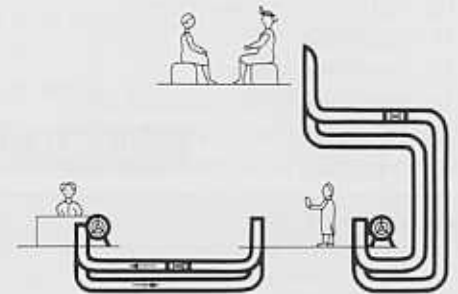
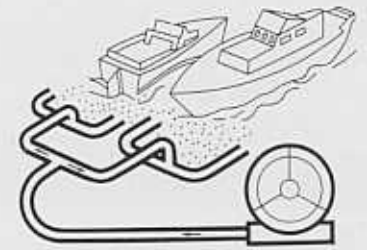
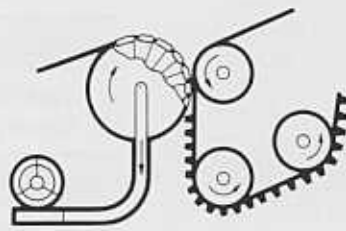
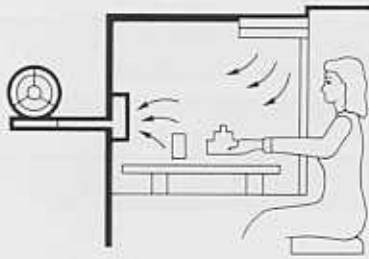
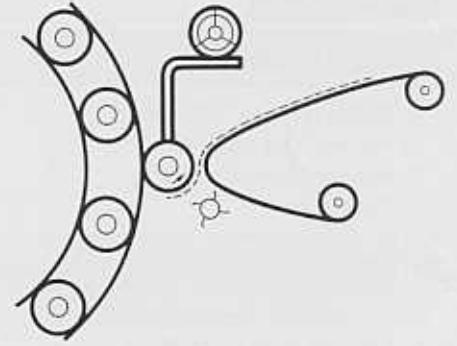
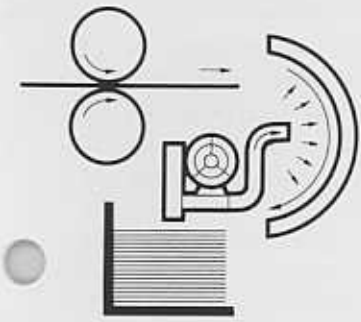

Application Ideas

CONTENTS

PRESSURE 4

FOOD PROCESSING 4

1. Bottle washing machine
2. Egg washing machine
3. Ham processing
4. Tray drier

PACKING MACHINERY 5 – 6

5. Printing ink drying application
6. Printing press application
7. Printing shop application
8. Automatic paper positioning
9. Paper feeder
10. Data processing
11. Photo paper printing application
12. Printing press application
13. Film drying process

COMPUTER EQUIPMENT 6

14. Tape spinning process
15. Air bearing

MEDICAL EQUIPMENT 6 – 7

16. Rubber glove inspection
17. Humidifier
18. Pneumatic massage
19. Health application (Bubble bath)
20. Air-mattress application
21. Aspiration equipment application

PAPER PROCESSING MACHINERY 7 – 8

22. Paper cutting air cushion
23. Paper warehouse
24. Scrap tape collector

MATERIALS HANDLING 8

25. Materials handling
26. Cement hopper application

TEXTILE MACHINERY 8

27. Automatic knitting machine
28. Circular knitting machine

INDUSTRIAL PLANT 9 – 11

29. Plating gas exhaust
30. Machining application (Oil mist spray)
31. Plating baths
32. Plating
33. Plating application
34. Molding process
35. Grinder and buffer
36. Sand blasting
37. Furnace air supply
38. Spraying
39. Air brush
40. Brick and tile mold cleaner
41. Chip removal

AGRICULTURAL MACHINERY 11

42. Vegetable washing machine
43. Granary application

FISH HATCHERIES 11

44. Waste decomposer
45. Fish hatchery

BOTTLING PLANT 11

46. Bottling plant

OTHER APPLICATIONS 12

47. Boat Marinas
48. Golf ball dispenser
49. Pipe cleaning
50. Water treatment plant
51. Anti-freezing application

SUCTION 13

FOOD PROCESSING 13 – 14

1. Packing of candies
2. Persimon peeler
3. Sausage peeler
4. Filtering
5. Juicer
6. Vegetable wrapping
7. Food processing machine
8. Egg packing machine
9. Bottling machine
10. Packaging milk

PACKING MACHINERY 14 – 15

- 11. Wrapping machine for laundry
- 12. Labelling machine
- 13. Packaging machine
- 14. Cardboard packaging machine
- 15. Bag opener (Vertical bagging machine)
- 16. Bag opener (Horizontal bagging machine)
- 17. Suction transferring

PRINTING COPY MACHINE 15 – 17

- 18. Vacuum forming machine
- 19. Dry type copying machine
- 20. Paper punching machine
- 21. Thin material press
- 22. Collating
- 23. Photographic printing
- 24. Printing press applications
- 25. Card transfer
- 26. Printing of microfilm
- 27. Photographic enlargements
- 28. Printing
- 29. Industrial cameras

COMPUTER EQUIPMENT 17 – 18

- 30. Office computer
- 31. Magnetic tape transfer
- 32. Retarding the tape speed
- 33. Optical card reading

MEDICAL EQUIPMENT 18

- 34. Dental equipment

PAPER PROCESSING MACHINERY 18

- 35. Tape slitter

MATERIALS HANDLING 18

- 36. Suction handling equipment (Traveling)

TEXTILE MACHINERY 19 – 20

- 37. Industrial sewing machine
- 38. Cloth pressing machine
- 39. Weaving machine
- 40. Treatment of yarn
- 41. Socks knitting machine
- 42. Automatic weaving machine
- 43. Clothing factories

INDUSTRIAL PLANT 20 – 21

- 44. Drying machine
- 45. Vacuum dryer
- 46. Welding machine
- 47. Work holder
- 48. Chip removal
- 49. Lifting the plywood
- 50. Clean room

AGRICULTURAL MACHINERY 21

- 51. Hopper loader
- 52. Loading of bags
- 53. Powder and bulk grain conveying

PLASTIC (SYNTHETIC RESIN) MACHINERY 21

- 54. Plastic film process

FISH HATCHERIES 22

- 55. Fish transferring

OTHER APPLICATIONS 22

- 56. Drying vehicles after washing
- 57. Forced ventilation in train car
- 58. Collecting the chips from disc cutter
- 59. Drying for stain removal
- 60. Laboratory filtering systems

PRESSURE AND SUCTION 23

FOOD PROCESSING 23

- 1. Cookie baking machine

MEDICAL EQUIPMENT 23

- 2. Pneumatic message handling systems
- 3. Beauty surgery application

AGRICULTURAL MACHINERY 23

- 4. Dairy milking

OTHER APPLICATIONS 23

- 5. Pneumatic paper handling system for drive-in banks

MAKING AIR WORK FOR YOU

FUJI ELECTRIC's patented Ring Blower makes use of advanced aerodynamic principles to produce a continuous high-pressure airflow similar to that provided by a multi-stage blower at a fraction of the cost. Being unusually small and light with impeller and motor in one compact unit, the Ring Blower is ideally suited to many industrial applications.

This user-oriented ideas book illustrates many actual applications where this convenient and highly-dependable blower has been used as original equipment, or has upgraded the performance of existing machinery or systems.

The object of this booklet is two-fold. First to introduce to the many advantages and features of Ring Blower and secondary to spark your imagination as to how this blower could be used in your particular field. Experience has shown that the Ring Blower will frequently eliminate the need for

expensive and complicated machinery and do a better job at lower cost and increased efficiency.

FUJI ELECTRIC's Sales Department is at your service. Should you require further information regarding Ring Blowers or other FUJI ELECTRIC equipment, please contact us directly.

FOOD PROCESSING

1. Bottle washing machine

Used to dry inside of just-washed bottles.

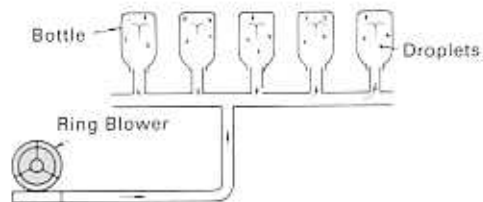

2. Egg washing machine

Incorporated with automatic washing and drying machines and used to dry just-washed eggs.

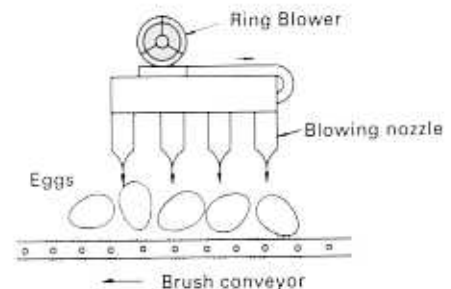

3. Ham processing

Used to blow water droplets off hams after they have been processed.



4. Tray drier

Used to dry just-washed trays with warm air.

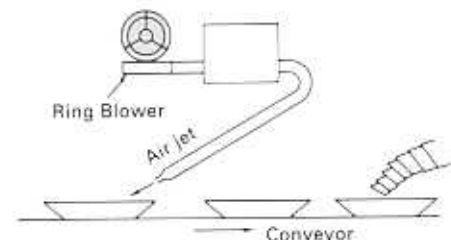

PACKING MACHINERY

5. Printing ink drying application

Prevents smudging by drying printing ink as paper is printed.

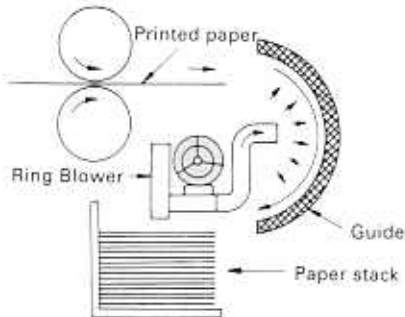

6. Printing press application

Used to float paper below a guide plate by blowing air from nozzles to keep the printed surface of the paper clean.

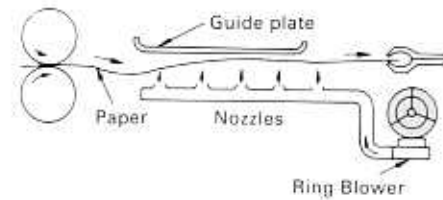

7. Printing shop application

Used to separate, pick up and feed pieces of paper that are stuck together.

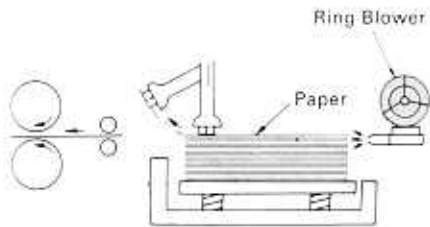

8. Automatic paper positioning

Used to keep printing or binding paper positioned correctly on a tilted air table.

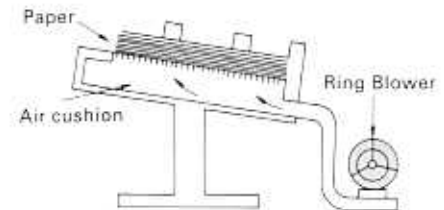

9. Paper feeder

Used to blow air between sheets of paper to facilitate feeding.

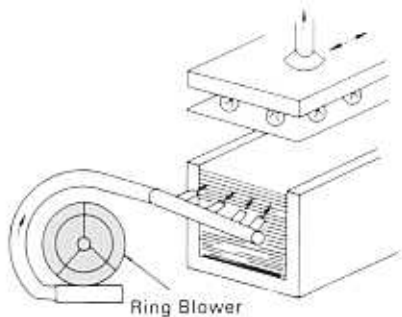

10. Data processing

Used to maintain paper in the proper position on a transfer roller by pushing a hopper up.

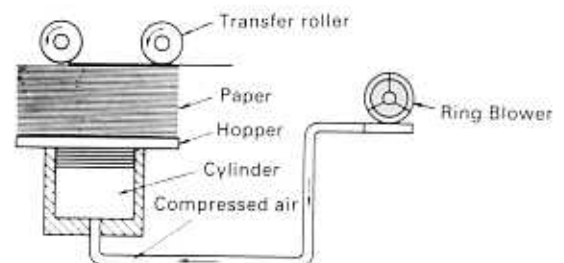

11. Photo paper printing application

Used to dry photo-sensitive paper with clean air.

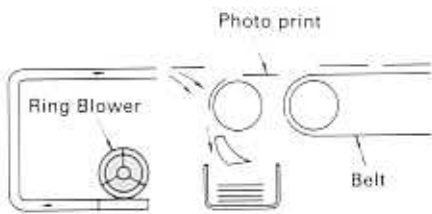

12. Printing press application

Used to blow a powder over newly printed paper to blot the ink and keep the paper clean.

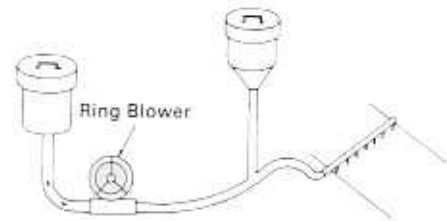

13. Film drying process

Used to supply oil-free air for film drying process.



COMPUTER EQUIPMENT

14. Tape spinning process

Used to dry and clean spinning tape.

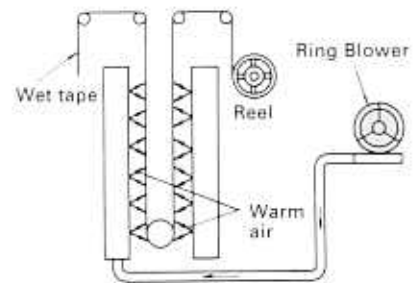

15. Air bearing

Used to prevent friction between tape and guide wheel to ensure a long service life.

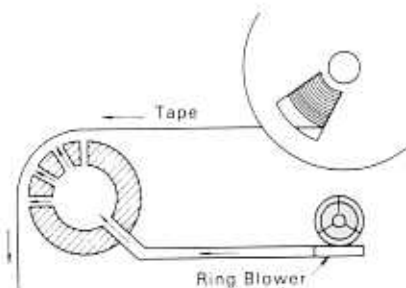

MEDICAL EQUIPMENT

16. Rubber glove inspection

Used to check the pin holes in rubber gloves.

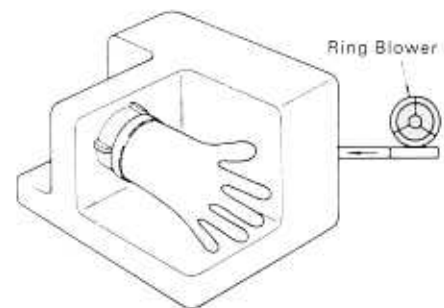

17. Humidifier

For maintaining baby crib atmosphere at correct humidity.

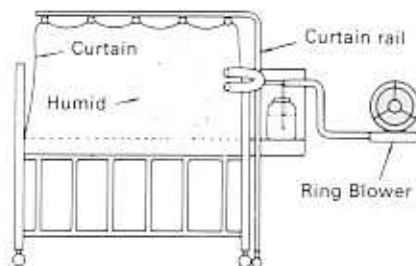

18. Pneumatic massage

Supplies air to inflatable leg collars which help to improve a patients blood circulation.

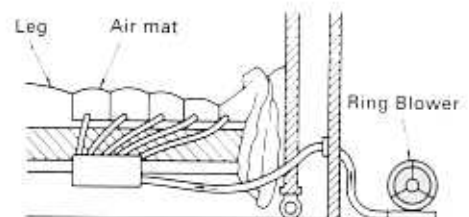

19. Health application (Bubble bath)

Provides a gentle massage by aerating bath water through a perforated bath mat.

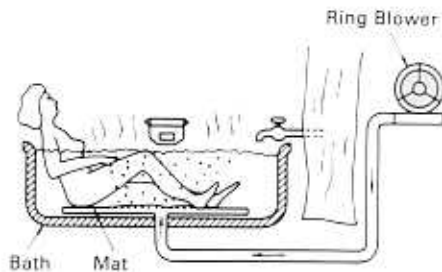

20. Air-mattress application

Used to keep air-mattress inflated at correct pressure for patients to prevent poor circulation and bed sores.

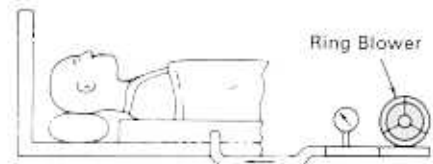

21. Aspiration equipment application

Used for the equipment to prevent irregular breathing of patients.

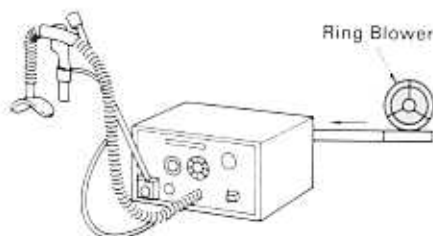

PAPER PROCESSING MACHINERY

22. Paper cutting air cushion

Permits paper to be moved easily on cutting table.

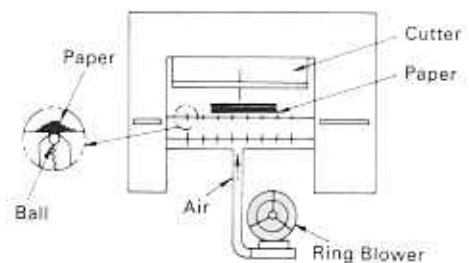

23. Paper warehouse

Hot air under pressure is used to dry and air the paper stored in a warehouse.

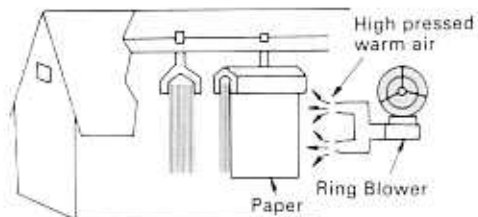

24. Scrap tape collector

Used to remove scraps of tape and pieces of paper. (This can be also carried out using the suction side of the Ring Blower.)

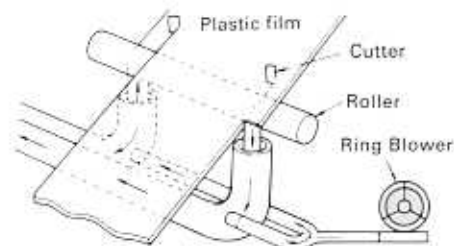

MATERIALS HANDLING

25. Materials handling

Used in pneumatic systems to transport small pellets, powders and other such materials. (This can be also carried out using the suction side of Ring Blower.)

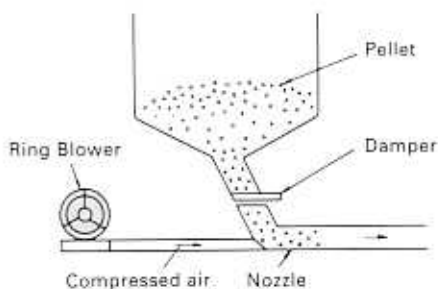

26. Cement hopper application

Used to blow air into hopper to keep cement from sticking to its walls.

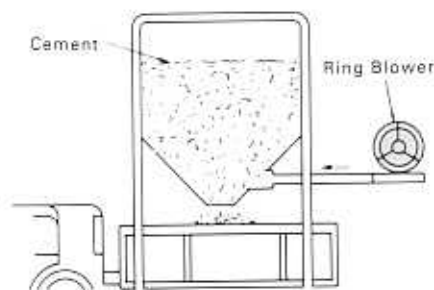

TEXTILE MACHINERY

27. Automatic knitting machine

Used to stretch yarn tight to make knitting easier and collect lint.

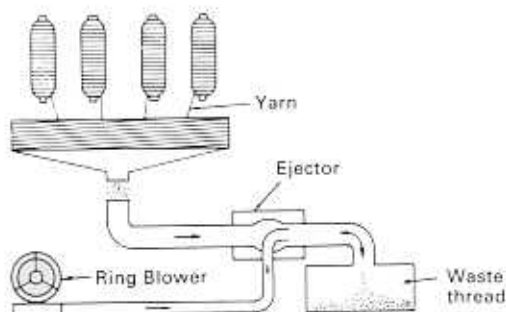

28. Circular knitting machine

Used to blow lint away from yarn when knitting.

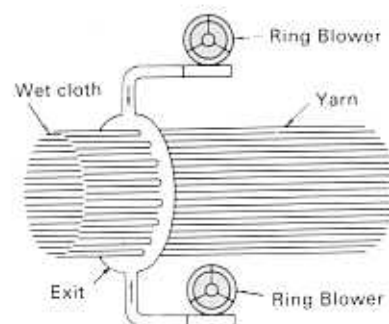

INDUSTRIAL PLANT

29. Plating gas exhaust

Used to blow off the gas generated through plating.

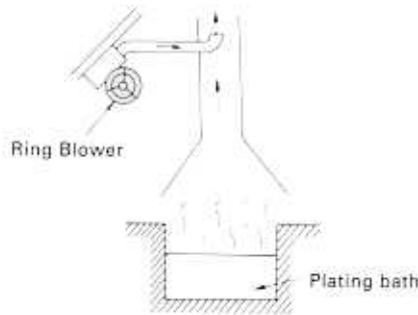

30. Machining application (Oil mist spray)

Improves work and tool service life by cooling spray.

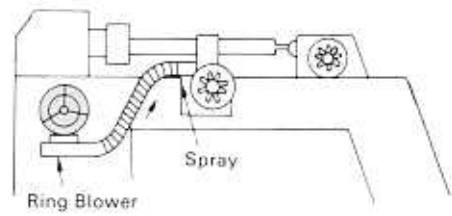

31. Plating baths

Air circulates the electrolyte in electroplating tanks and improves plating quality. Bubbles are dispersed and plating is more even and faster.

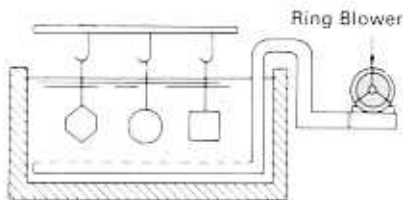

32. Plating

Used to circulate a plating liquid to keep it well-mixed and at a constant temperature.

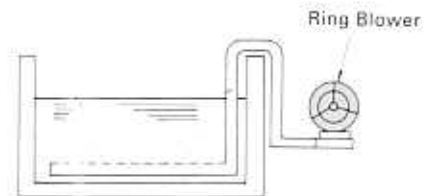

33. Plating application

Used to blow droplets off just plated objects.

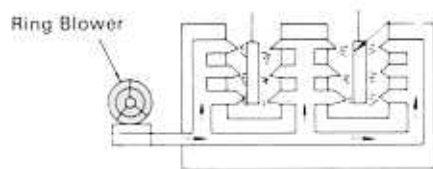

34. Molding process

Used to remove pressed products from molds.

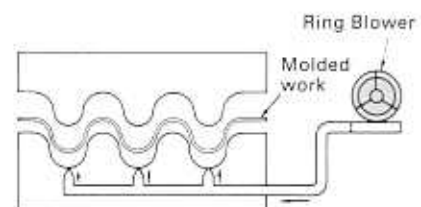

35. Grinder and buffer

Used to collect grinding dust. Negative pressure at the wheel removes dust and debris, which are then blown into a collection sack for later removal.

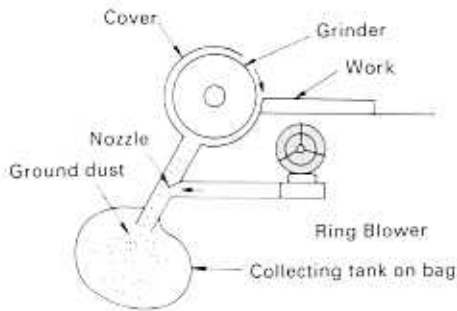

36. Sand blasting

Used to supply a high-pressure stream of air for sand blasting.

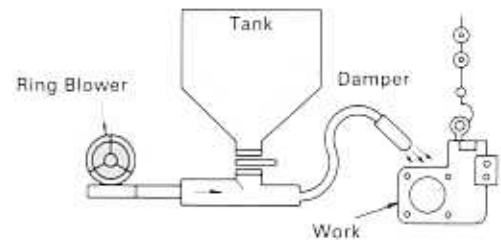

37. Furnace air supply

Used to atomize fuel for optimum combustion.

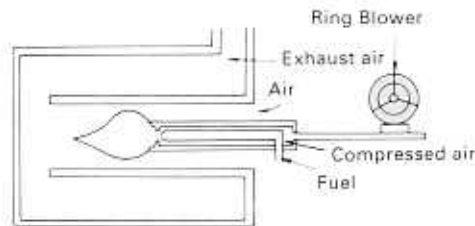

38. Spraying

Used to supply an oil-free, high-pressure stream of air for spraying applications.

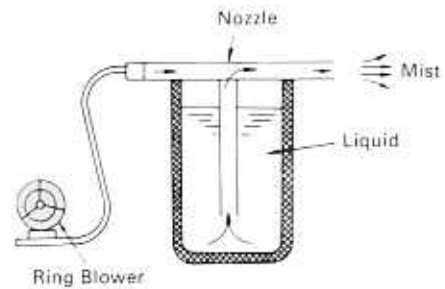

39. Air brush

Used to supply oil-free, high-pressure stream of air for spray painting.

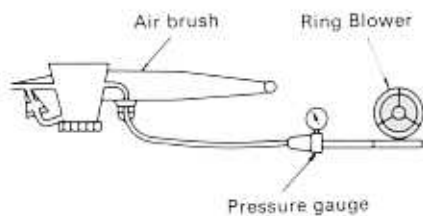

40. Brick and tile mold cleaner

A rotary brush and air jet unit removes clay from brick and tile molds and delivers it to a bin.

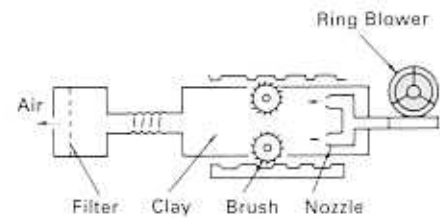

41. Chip removal

Used to blow chips away from the work surface of a lathe.

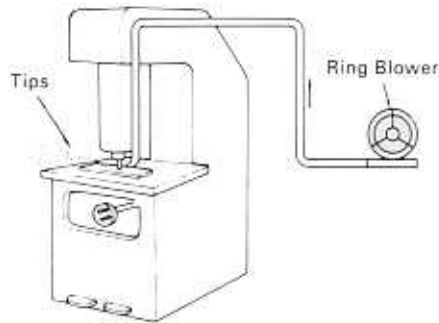

AGRICULTURAL MACHINERY

42. Vegetable washing machine

Agitates water in vegetable washing tank to remove dirt.

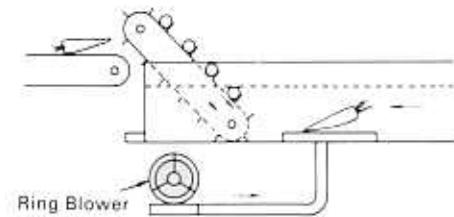

43. Granary application

Used to convey the wheat in a pneumatic grain handling system.

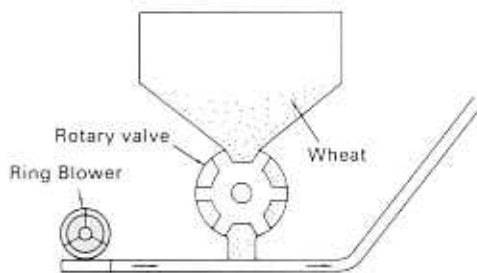

FISH HATCHERIES

44. Waste decomposer

Used to aerate compost tank to hasten decomposition.

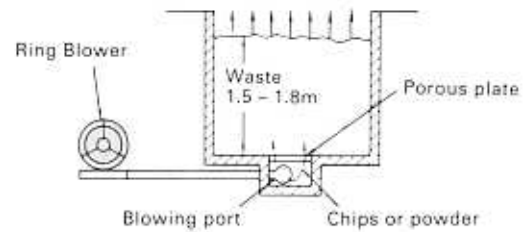

45. Fish hatchery

Used to aerate and oxygenate fish hatchery ponds.

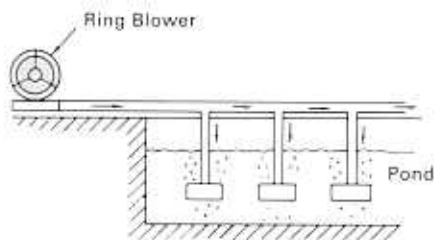

BOTTLING PLANT

46. Bottling plant

Used to blow water droplets away from the rims of bottles.

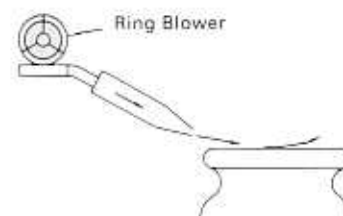

OTHER APPLICATIONS

47. Boat marinas

Bubbles prevent ice formation around boats.

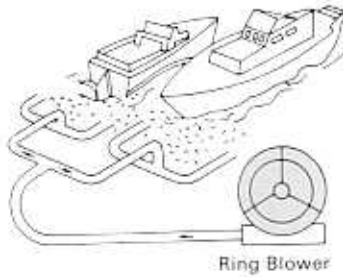

48. Golf ball dispenser

Used to supply air to golf ball dispenser.

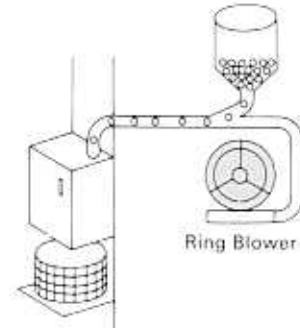

49. Pipe cleaning

Used for pipe air blast to remove dusts and dirt.

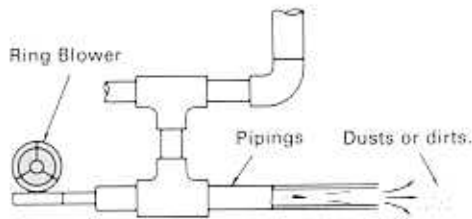

50. Water treatment plant

Used to supply air to agitate the sediment in shallow water treatment plant.

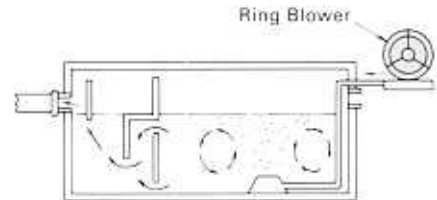

51. Anti-freezing application

Used to blow air through pipes prevent ice formation.

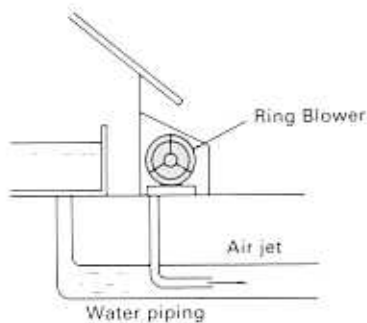

FOOD PROCESSING

1. Packing of candies

Used for packing candy into boxes.

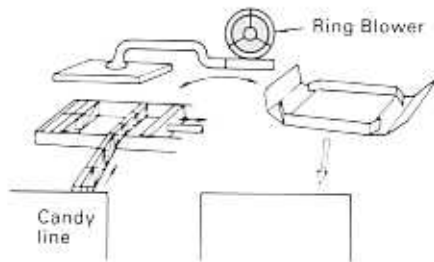

2. Persimon peeler

Used to hold persimon fruit on peeler.

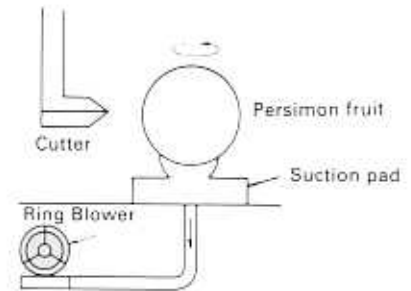

3. Sausage peeler

Used for sausage peeler to remove and collect skin.

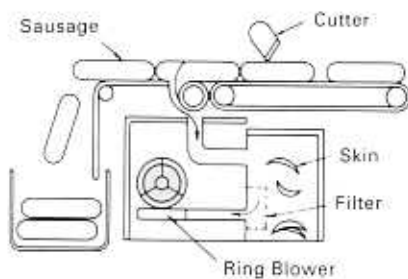

4. Filtering

It is used to shorten filtering time by using a strong suction.

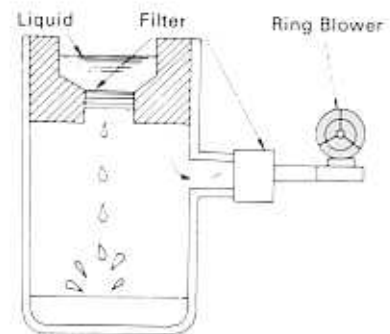

5. Juicer

It is used to assist in the extraction of fruit juice.

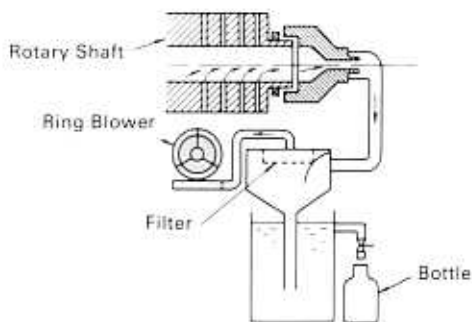

6. Vegetable wrapping

Used to wrap vegetables with film.

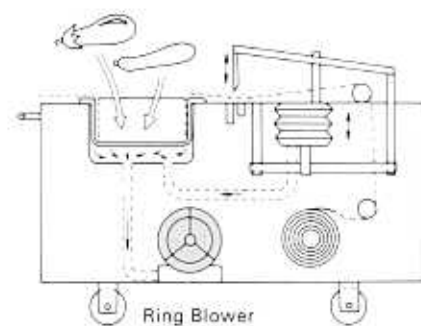

7. Food processing machine

Used to season food.



8. Egg packing machine

Provides a vacuum to handle fragile material like eggs.

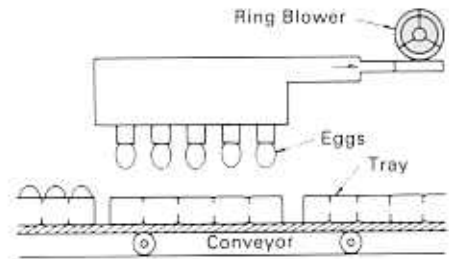

9. Bottling machine

Removes air from feed tank by a steady suction to ensure a rapid and smooth liquid filling operation.

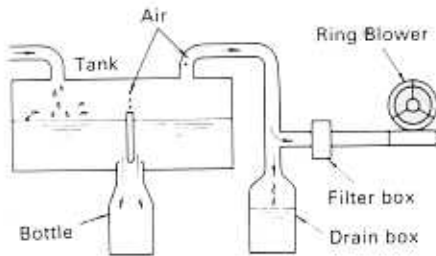

10. Packaging milk

Used to remove froth away when milk containers are filled.

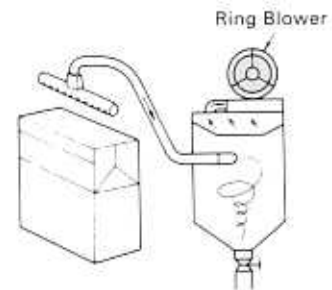

PACKING MACHINERY

11. Wrapping machine for laundry

It is used to wrap the clothings after laundry.

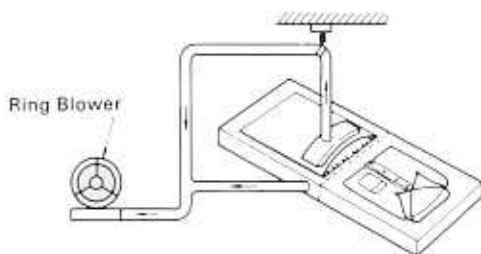

12. Labelling machine

Vacuum label holders automatically apply the labels stripped from the roller to the surface of bottles.

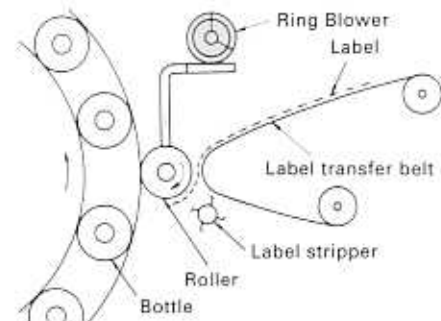

13. Packaging machine

Used to collect excess powder from the table of the packaging machine.

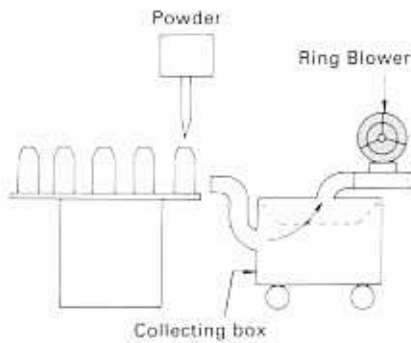

14. Cardboard packaging machine

Used with perforated conveyor belt to hold boxes in position for packing.

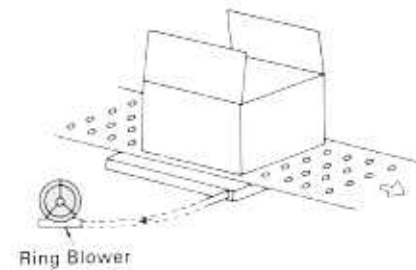

15. Bag opener (Vertical bagging machine)

Used to hold bags vertical and open to allow them to be filled with grain or powder.

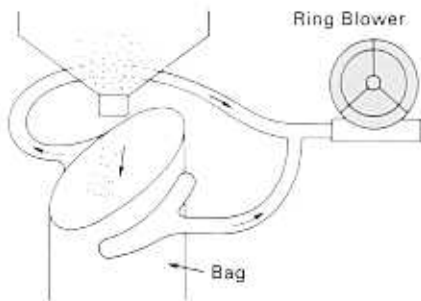

16. Bag opener (Horizontal bagging machine)

It is used for bagging of cotton goods, plastic resins, medicines, etc.

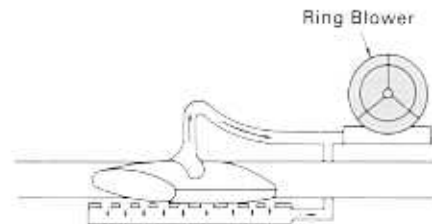

17. Suction transferring

Used for transferring light loads by suction. This unattended operation may save manpower.

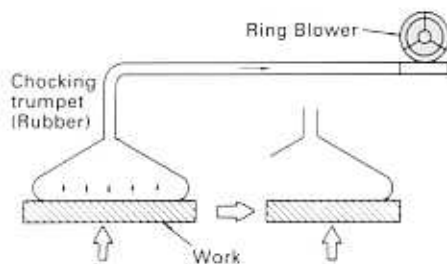

PRINTING COPY MACHINE

18. Vacuum forming machine

Used for forming the wrapping film of vegetable.

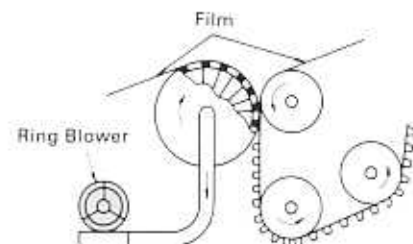

19. Dry type copying machine

Used to hold down the paper and to collect the dust inside a machine at once.

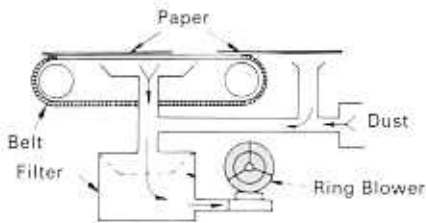

20. Paper punching machine

Used to collect waste paper and deposit it in waste bin.

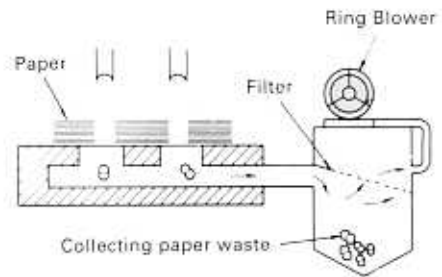

21. Thin material press

It removes surplus air from surfaces.

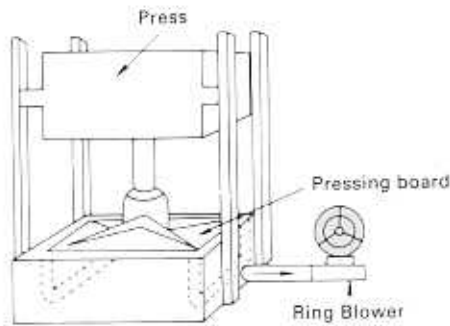

22. Collating

Used to vacuum or blow waste paper away after cutting. (In suction, a filter box is needed.)

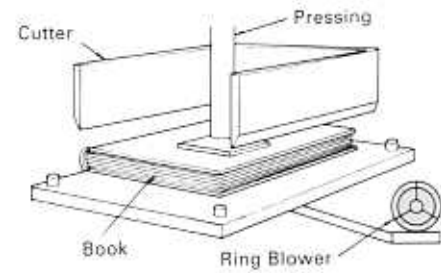

23. Photographic printing

Used to hold the negative and printing paper in intimate contact during exposure.

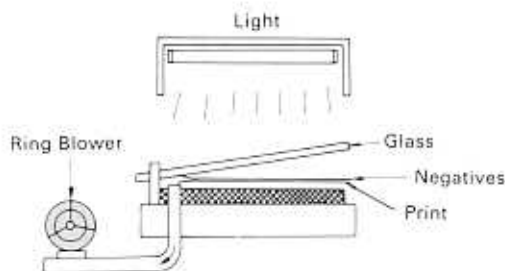

24. Printing press applications

Used to hold the paper on the retarding roller after it leaves the press, since printed paper must be retarded in high speed press.

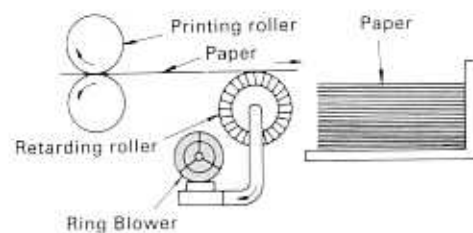

25. Card transfer

Used to take the bottom card from a stack of cards in a hopper.

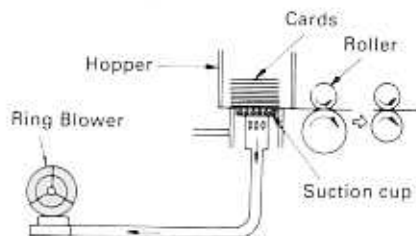

26. Printing of microfilm

Used to hold microfilm and printing paper together during photo enlarging.

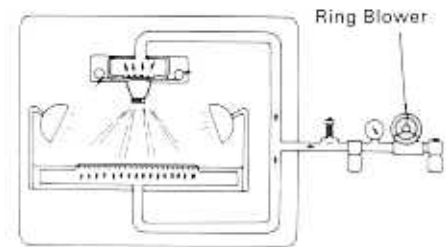

27. Photographic enlargements

Used to keep printing paper correctly positioned on an enlarging board.

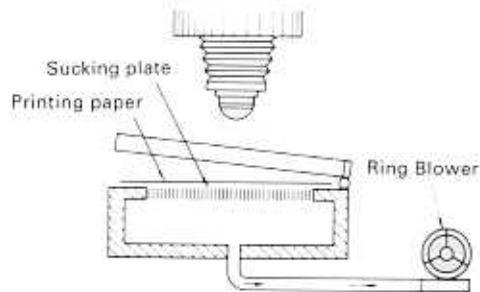

28. Printing

Used to hold the paper in position during the printing.

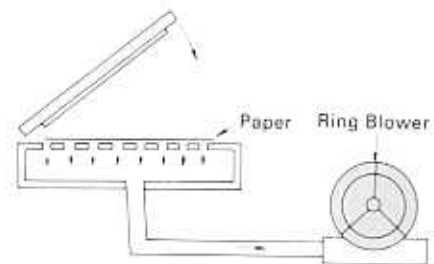

29. Industrial cameras

Used to hold film in its precise position.

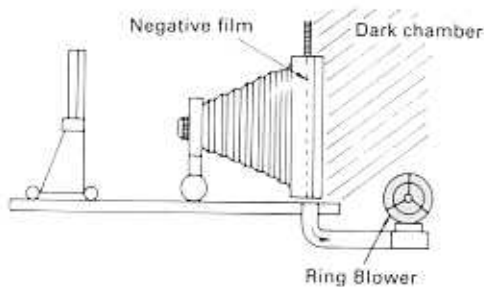

COMPUTER EQUIPMENT

30. Office computer

Used to keep the precise tension on the magnetic tape of office computers.

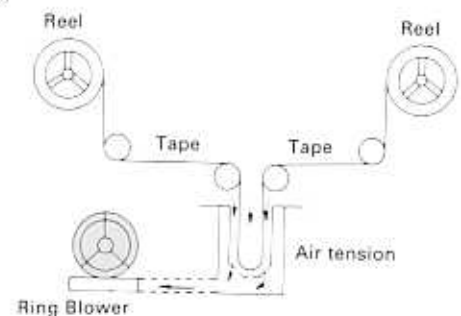

31. Magnetic tape transfer

Used to maintain proper tape tension during data transfer.

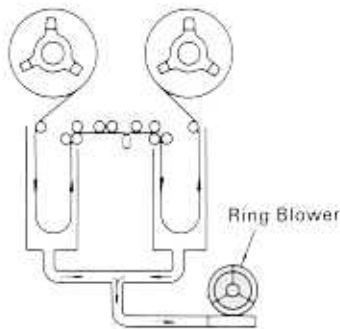

32. Retarding the tape speed

Used to retard the speed of magnetic tape or film.

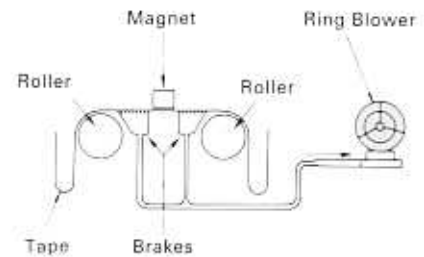

33. Optical card reading

Used to hold cards to the perforated conveyor belt, and to feed to the collection box.

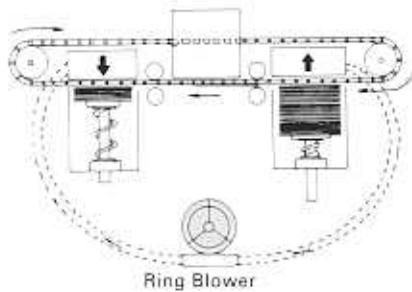

MEDICAL EQUIPMENT

34. Dental equipment

Used to vacuum spit and dirt away from the mouth during treatment.

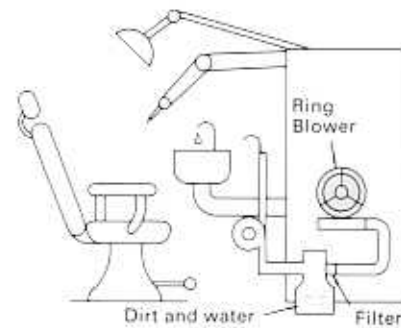

PAPER PROCESSING MACHINERY

35. Tape slitter

Used to remove scrapped tape for automatic wrapping machine.

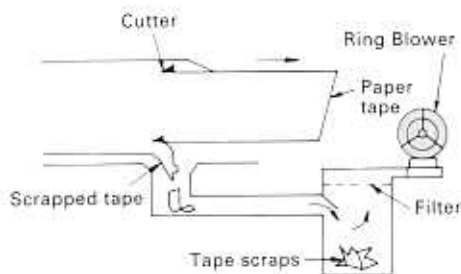

MATERIALS HANDLING

36. Suction handling equipment (Traveling)

The larger the suction cup the heavier the material which can be handled.

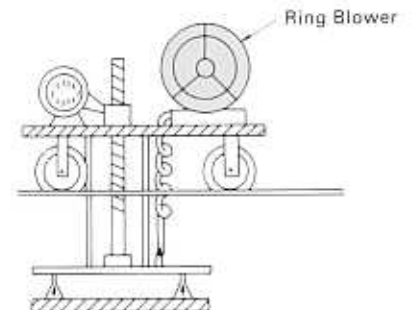

TEXTILE MACHINERY

37. Industrial sewing machine

Used to remove waste and lint which are produced during sewing machine operations.

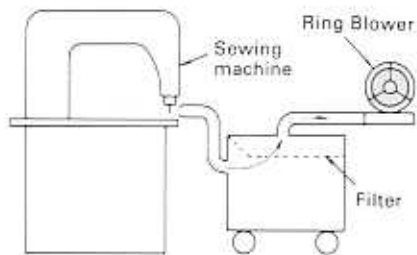

38. Cloth pressing machine

Used to suck steam through mat in pressing clothing.

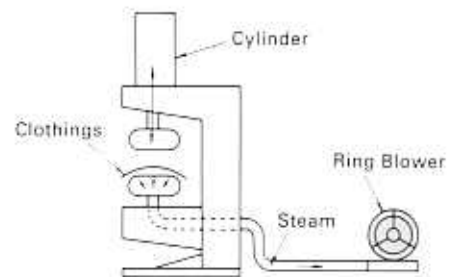

39. Weaving machine

Used to keep suitable tension of thread, and collect lint and waste.

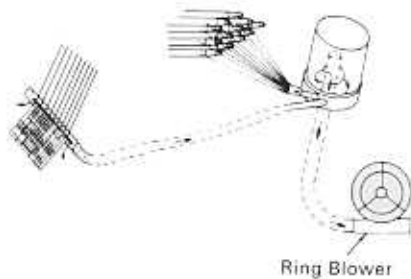

40. Treatment of yarn

Used to remove the oil and water mist in the process of yarn treatment by suction.

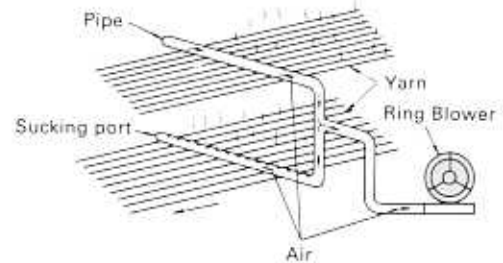

41. Socks knitting machine

Used to hold socks in their correct position by suction and prevent yarn entanglement.

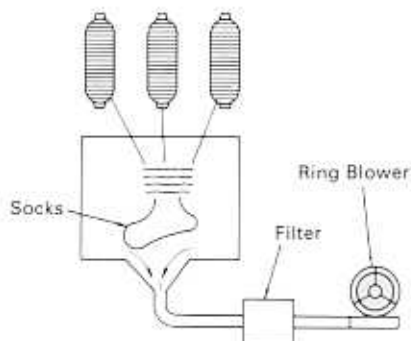

42. Automatic weaving machine

Used to maintain the tension on the yarn, remove lint and prevent stray of the yarn before feeding to the loom through the steady pneumatic holding force.

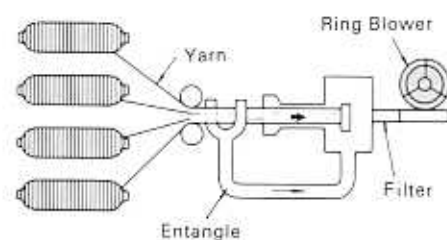

43. Clothing factories

Used to remove waste and lint automatically during trimming operations.

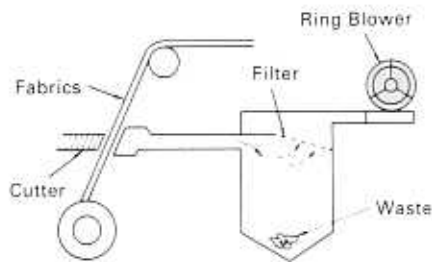

INDUSTRIAL PLANT

44. Drying machine

Used to dewater sewage. (Pay attention to steam trap.)

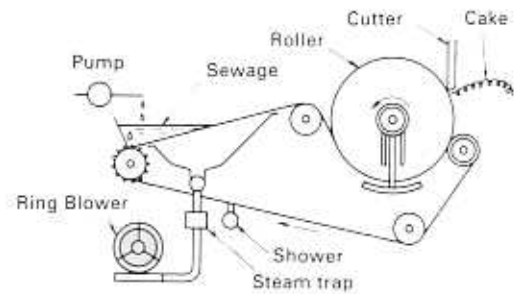

45. Vacuum dryer

Used to dry sand.

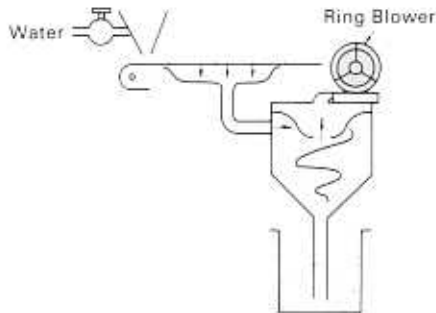

46. Welding machine

Used to remove smoke, heat and dust generated during welding operations.

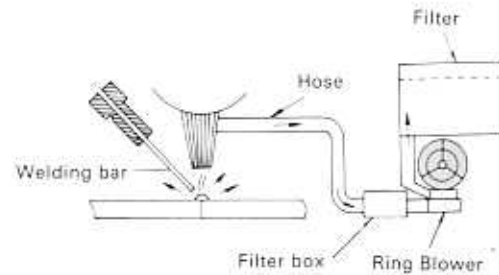

47. Work holder

Used to hold non-magnetic materials such as plastic and wooden sheets on a work table without marring their surfaces.

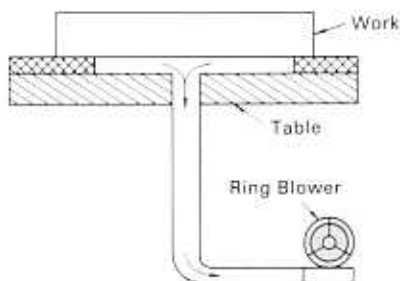

48. Chip removal

It can remove plastic chips and other materials during machining.

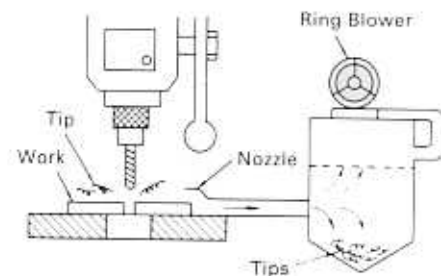

49. Lifting the plywood

Used to lift and transfer the plywood and sheet steel.

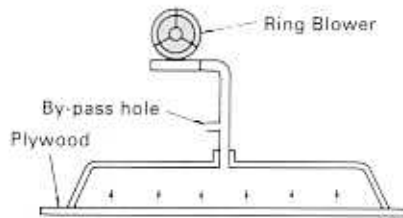

50. Clean room

Used to maintain extremely clean air or to remove harmful chemical vapors during clean room operations.

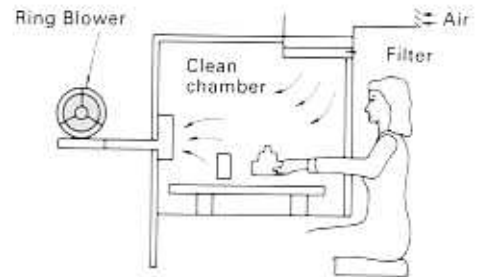

AGRICULTURAL MACHINERY

51. Hopper loader

Used to convey materials including plastic resin P.V.C. polyethylene from storage locations.

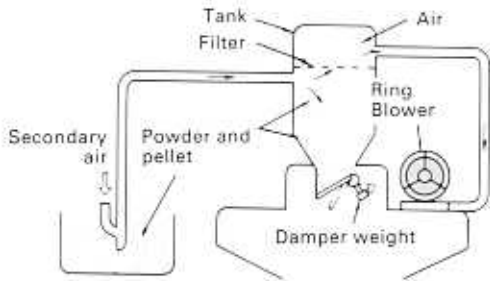

52. Loading of bags

Used to load the bags of rice, wheat and others.

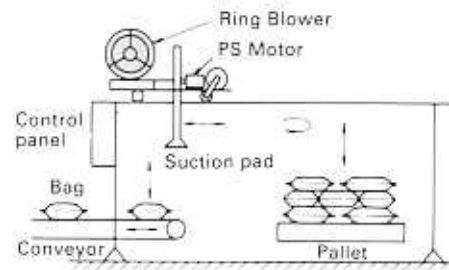

53. Powder and bulk grain conveying

Used to transfer rice, wheat, bean, powder, almond, nuts, etc.

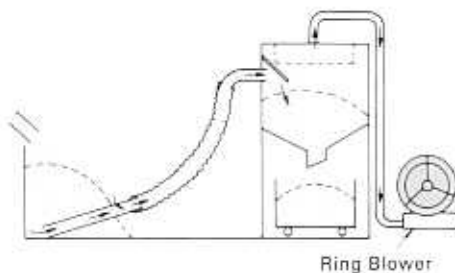

PLASTIC (SYNTHETIC RESIN) MACHINERY

54. Plastic film process

Used to hold plastic sheets firmly on a suction roller.

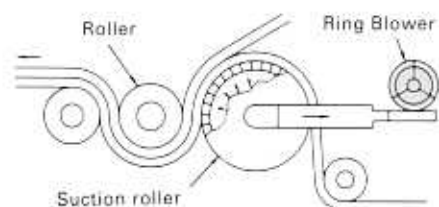

FISH HATCHERIES

55. Fish transferring

Used to transfer small fishes in hatchery.

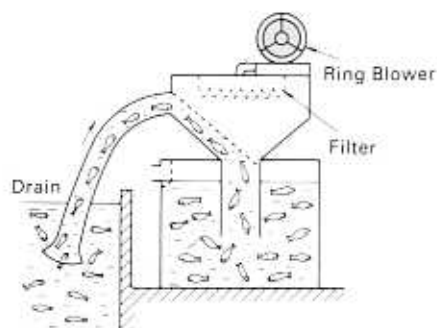

OTHER APPLICATIONS

56. Drying vehicles after washing

Used to remove water from mops, which have dried car after washing. Note water trap needed.

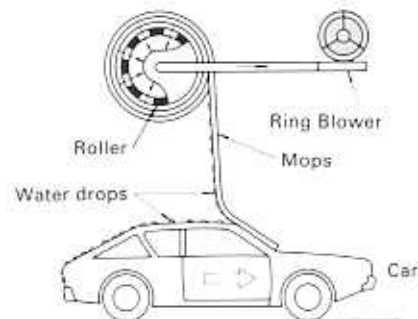

57. Forced ventilation in train car

Used to force ventilate small areas such as toilets and dining galleys. These units were used in Japan's super express trains.

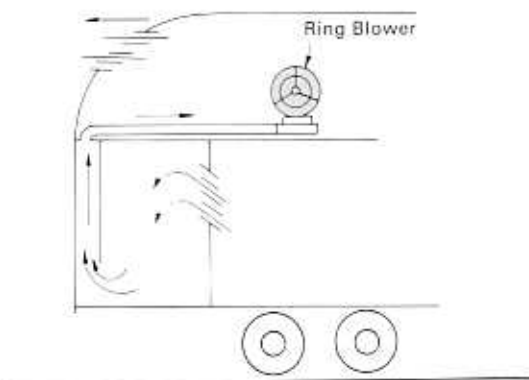

58. Collecting the chips from disc cutter

Used to collect chips from record disc cutter.

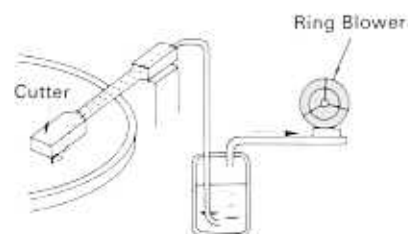

59. Drying for stain removal

Used to dry clothings quickly after using dry cleaning fluid.

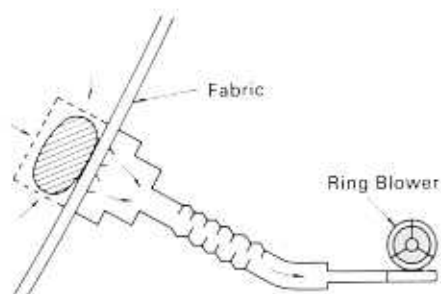

60. Laboratory filtering systems

Used to shorten the filtering time, since the backflow of liquid is eliminated.

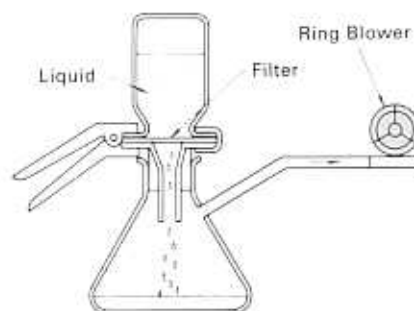

FOOD PROCESSING

1. Cookie baking machine

Used in cookie baking machine to drop the cookie dough onto conveyor.

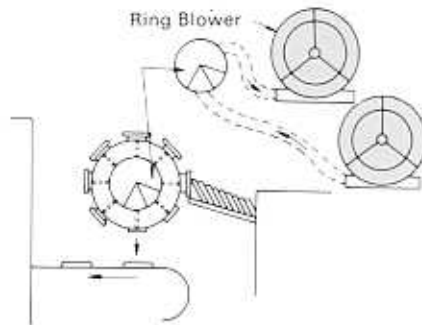

3. Beauty surgery application

Used to extract milk from the breasts of nursing women and other beauty applications.

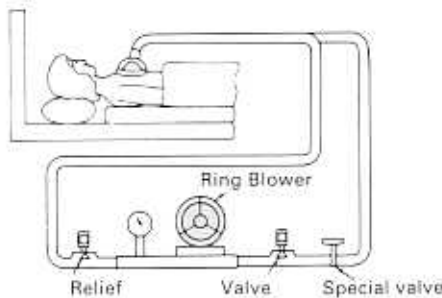

OTHER APPLICATIONS

5. Pneumatic paper handling system for drive-in banks

Used to allow bank customers to make bank deposits and withdrawals without leaving their cars.

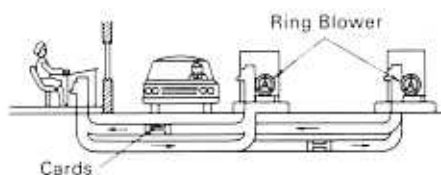

MEDICAL EQUIPMENT

2. Pneumatic message handling systems

Used to send documents within hospitals and office buildings.

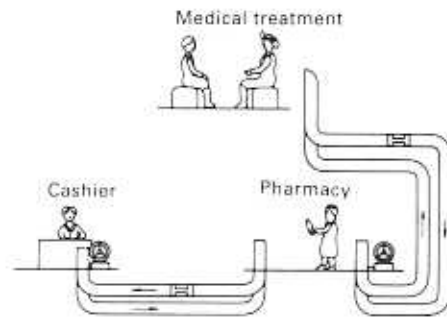

AGRICULTURAL MACHINERY

4. Daily milking

Used for daily milking under highly sanitary condition. The Ring Compressor is quiet in operation.

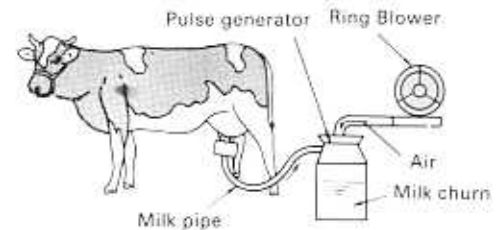

Pressure	Pressure supply	Drying
	Cooling	Spatter, spray
	Air cushion	Combustion, air supply
	Ventilation	Warehouse ventilation
	Blast, purge	Humidification
	Holding	Separation
	Breaking	
Suction	Vacuum	
	Collection	
	Hold, tension, stretching	
	Vacuum-transport	
	Transport air flow	
	Vacuum supply	